

SUPERPRO

Premium Grade Stainless Steel Factory-Built Chimney

For the Chimney Professional
Who Demands the Best.



SuperPro offers the latest technology in factory-built chimney design-providing superior performance, durability and safety.

FEATURES

- Superior Performance
- 1" of Solid Pack Insulation
- Premium Grade Stainless Steel
- Certified to UL 103 HT for All Fuel Use



SuperPro Technical Data Sheet

For the Chimney Professional Who Demands the Best...

SuperPro incorporates the latest technology in factory-built chimney design; providing superior performance, durability, and safety. SuperPro is designed to accompany today's appliances, which are engineered to produce low emissions and high heat. This makes SuperPro the choice of professionals who are looking for a better-quality, factory built chimney system.

CERTIFICATION & APPLICATIONS

SuperPro is Safety Tested and Listed to applicable UL/ULC Standards. These include:

USA:UL 103-HT

Safety Standards for chimneys serving solid fuel and liquid fuel appliances. This chimney system has been designed for use on wood stoves, fireplaces and residential furnaces in the U. S. market.

Allowable Flue Gas Temperatures are:

Maximum Continuous	1000° F / 540° C
Brief Forced Firing	1400° F / 760° C (60 min.)
Creosote Burn Out	2100° F / 1150° C (3 x 10 min.)

Smart Choice Lifetime Warranty

The SuperPro Smart Choice Lifetime Warranty applies to all Chimney components (not just insulated lengths) making SuperPro chimney the smart choice, every time. (See written Warranty for details).

Enhanced Features

Premium Grade Stainless Steel construction of both the inner liner and outer casing make SuperPro HT chimney extremely corrosion resistant. Embossed couplers do not allow moisture to penetrate the chimney's outer wall. Sections simply 'twist-lock' together and may be secured with optional Locking Bands. The SuperPro product line features **Deluxe Chimney Support Components** that will enhance any installation. **Brass Trims** are used to embellish the chimney support component parts that may be installed inside the home.

Supports/Framing

All SuperPro Supports are designed to carry four times the combined weight of each system at maximum allowable height.

Support and Framing Dimensions Table				
	Ceiling Support	Wall Support	Cath. Ceiling Support	Roof Support
Support	50'	38'	38'	50'
Diameter	Framing Dimensions			
5" Dia.	12-3/8" x 12-3/8"	14-3/8" x 14-3/8"	11" x 11"	N/A
6" Dia.	12-3/8" x 12-3/8"	14-3/8" x 14-3/8"	12" x 12"	N/A
7" Dia.	13-3/8" x 13-3/8"	14-3/8" x 14-3/8"	13" x 13"	N/A
8" Dia.	14-3/8" x 14-3/8"	14-3/8" x 14-3/8"	14" x 14"	N/A

CONSTRUCTION

All SuperPro Twist-Lock Couplers are embossed (not lanced) and seams are weather-proofed to prevent moisture from entering the chimney. Insulation: The 1" space between the inner/outer walls is Solid Packed with Mineral Wool Fibre insulation to provide superior insulating qualities, in a "slim-line" design. Solid Pack design performs favorably to Blanket type and Air-Cooled chimney designs.

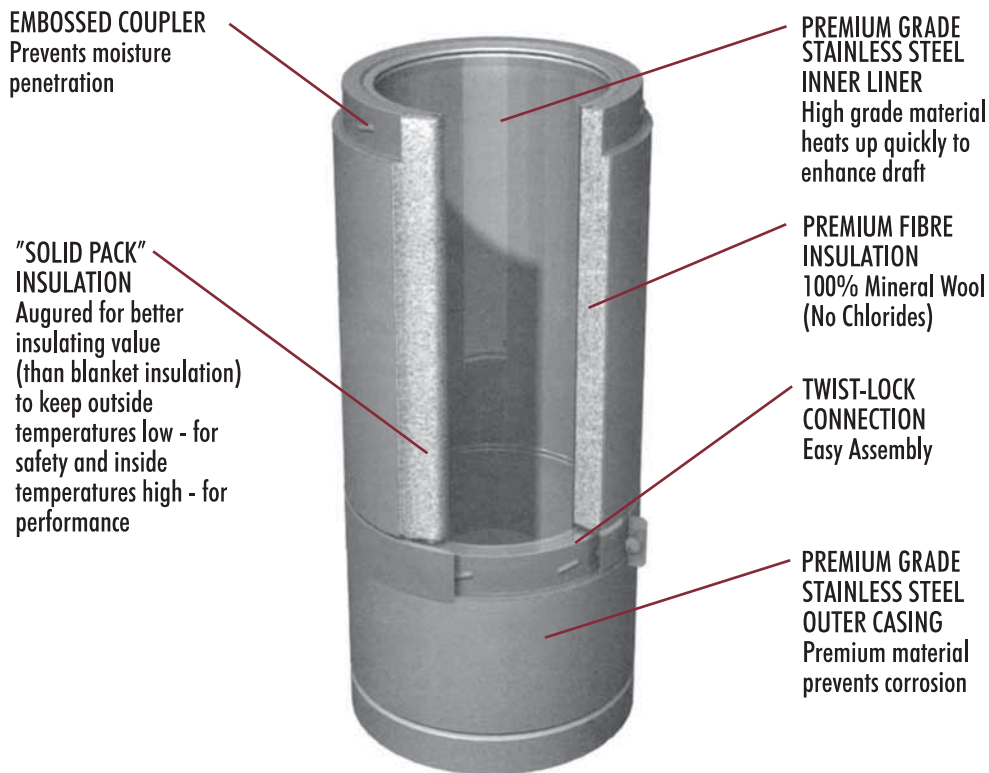

Smart Choice Lifetime Warranty

The SuperPro Smart Choice Lifetime Warranty applies to all Chimney components (not just insulated lengths) making SuperPro chimney the smart choice, every time. (See written Warranty for details).



Stainless Steel Chimney Lengths

HEIGHT REQUIREMENTS

The chimney must extend at least three feet above the highest point where it passes through the roof surface and at least two feet higher than any part of the building within a horizontal distance of ten feet.

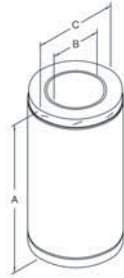
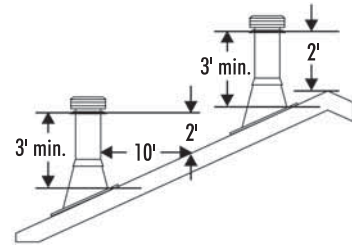

- Slim, advanced design allows for installation between 16" centers and still provides 2" clearance from combustible material.
- Secure twist-lock design couples chimney sections together with just a 1/8 turn.
- Sectional overlap of 1-1/8".
- Chimneys are sized according to the inner diameter and are available in 5, 6, 7 and 8".

Size	Dimensions			Product Code	Pack
	A	B	C		
5" x 36"	36"	5"	7"	SPR5L36	1
5" x 24"	24"	5"	7"	SPR5L24	1
5" x 18"	18"	5"	7"	SPR5L18	1
5" x 12"	12"	5"	7"	SPR5L12	1
5" x 6"	6"	5"	7"	SPR5L6	1
6" x 48"	48"	6"	8"	SPR6L48	1
6" x 36"	36"	6"	8"	SPR6L36	1
6" x 24"	24"	6"	8"	SPR6L24	1
6" x 18"	18"	6"	8"	SPR6L18	1
6" x 12"	12"	6"	8"	SPR6L12	1
6" x 6"	6"	6"	8"	SPR6L6	1
7" x 48"	48"	7"	9"	SPR7L48	1
7" x 36"	36"	7"	9"	SPR7L36	1
7" x 24"	24"	7"	9"	SPR7L24	1
7" x 18"	18"	7"	9"	SPR7L18	1
7" x 12"	12"	7"	9"	SPR7L12	1
7" x 6"	6"	7"	9"	SPR7L6	1
8" x 48"	48"	8"	10"	SPR8L48	1
8" x 36"	36"	8"	10"	SPR8L36	1
8" x 24"	24"	8"	10"	SPR8L24	1
8" x 18"	18"	8"	10"	SPR8L18	1
8" x 12"	12"	8"	10"	SPR8L12	1
8" x 6"	6"	8"	10"	SPR8L6	1

STAINLESS STEEL LOCKING BANDS

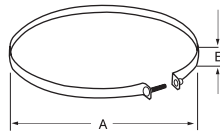
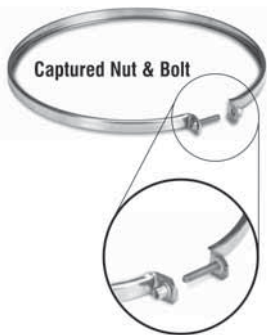

- Two flanges engage the grooves in each end of the adjoining sections holding them securely together.
- Locking Bands must be used:
 - on all sections that make up an offset.
 - on tee branch to attach a chimney length.
 - on any length suspended below the Cathedral or Roof Support.
- While Locking Bands are not required on other chimney lengths, their use is recommended for added safety and stability. It also provides a more attractive appearance.

Size	Dimensions		Product Code	Pack
	A	B		
5"	7"	7/16"	SPR5SLB	5
6"	8"	7/16"	SPR6SLB	5
7"	9"	7/16"	SPR7SLB	5
8"	10"	7/16"	SPR8SLB	5

Stainless Steel Elbows & Tees

CHIMNEY OFFSET CHARTS

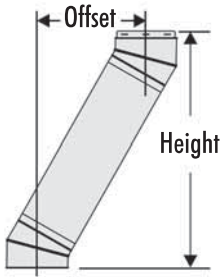

This chart has three columns for elbow angle required to achieve your desired offset. The first column ("Offset") is the horizontal measurement, at the chimney center line, of the offset needed to get around an obstacle. The second column ("Height") is the height of the assembled offset elbow to the top of the return elbow. Column 3 shows the appropriate lengths required.

1. Determine the distance of the offset required.
2. On the chart, find the predetermined distance required for the elbow kit under the corresponding chimney diameter.

3. After finding the offset, follow across the chart to find the specified height and appropriate chimney lengths required under their corresponding diameters.

All measurements in inches. Offset tolerances \pm one inch.

30° OFFSET CHART

Offset	Chimney Diameter				Height		Lengths Required						
	5"	6"	7"	8"	5"	6"	7"	8"	6"	12"	18"	24"	36"
3	2-3/4	3-1/8	3-1/2	4	10	11-5/8	13	14-1/2	-	-	-	-	-
5-1/4	5-1/4	5-5/8	6	7	14	15-7/8	17-1/4	18-3/8	1	-	-	-	-
9	8-1/4	8-5/8	9	10	19-1/4	21	22-3/8	24	-	1	-	-	-
11-1/4	11-1/4	11-5/8	12	13	24-1/2	26-1/4	27-5/8	29-1/8	-	1	-	-	-
14-1/4	14-1/4	14-5/8	15	16	29-3/4	31-3/8	32-7/8	32-3/8	-	-	1	-	-
-	16-5/8	17	17-1/8	18	35-5/8	37	38-1/2	39-1/2	1	-	-	1	-
25-1/4	20-1/4	20-5/8	21	22	39-1/2	41-7/8	43-1/4	44-3/4	-	-	-	-	1
-	22-5/8	23	23-1/2	24	46	47-1/2	49	50	1	-	-	-	1
-	22-5/8	26	26-1/2	27	51-1/4	52-5/8	54-1/8	55-1/2	-	1	-	-	1
-	28-5/8	29	29-1/2	30	56-3/8	57-3/8	59-3/8	60-3/8	-	-	1	-	1
-	31-5/8	32	32	33	61-5/8	63	64-1/2	65-1/2	-	-	-	1	1
-	34-1/8	34-1/2	35	36	65-7/8	67-1/4	68-3/4	69-1/2	1	-	-	1	1
-	37-1/8	37-1/2	38	39	71	72-1/2	74	75	-	1	-	1	1
42	-	-	-	43	70	-	-	-	-	-	-	-	2

15° OFFSET CHART

Offset	Chimney Diameter				Height		Lengths Required						
	5"	6"	7"	8"	5"	6"	7"	8"	6"	12"	18"	24"	36"
1-1/2	1-1/8	1-1/8	1-1/4	1-1/2	9	10	10-1/4	10-3/4	-	-	-	-	-
2-1/8	2-3/8	2-3/8	2-1/2	2-3/4	13-1/2	14-1/4	15	15-5/8	1	-	-	-	-
4	4	4	4	4	19-1/8	20-1/2	20-3/4	21	-	1	-	-	-
5-1/2	5-1/2	5-1/2	5-1/2	5-1/2	25	26-1/4	26-1/2	26-3/4	-	-	1	-	-
7-1/2	7	7	7	7	30-1/2	32	32-1/4	32-1/2	-	-	-	1	-
-	8-3/8	8-3/8	8-3/8	8-3/8	-	36-3/4	37	37-1/4	1	-	-	1	-
10-1/8	10-1/8	10-1/4	10-1/4	10-1/4	42	43-5/8	44	44-1/8	-	-	-	-	1
-	11-3/8	11-1/2	11-1/2	11-1/2	-	48-3/8	48-5/8	48-7/8	1	-	-	-	1
-	13	13	13	13	-	54-1/8	54-3/8	54-5/8	-	1	-	-	1
-	14-1/2	14-1/2	14-5/8	14-5/8	-	60	60-1/8	60-3/8	-	-	1	-	1
-	16-1/8	16-1/8	16-1/8	16-1/8	-	65-3/4	66	66-1/4	-	-	-	1	1
-	17-3/8	17-3/8	17-3/8	17-3/8	-	70-1/2	70-3/4	71	1	-	-	1	1
-	19	19	19	19	-	76-1/4	76-1/2	76-3/4	-	1	-	-	1
20	-	-	-	-	76	-	-	-	-	-	-	-	2

INSULATED 15° AND 30° ELBOW KITS

- The Insulated Elbow is used when an offset is required.
- Locking Bands must be used on all elbows.
- A maximum of 6 feet is allowable between offsets.
- Elbow is fully insulated and can be used at the same 2" clearance as chimney lengths.
- Elbow support must be used with all offset installations.
- Elbows do not have locking ridges and can be rotated to attain optimum positioning, and allow chimney to return to correct vertical alignment, prior to installing Locking Bands.

ELBOW KITS INCLUDE:
2 elbows, 4 Locking Bands & 1 Elbow Support



15° ELBOW

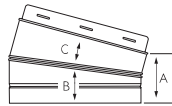

Size	Dimensions			Product Code	Pack
	A	B	C		
15° - 5"	3-3/8"	2-7/16"	1-15/16"	SPR5EL15K	1
15° - 6"	3-3/8"	2-1/2"	2"	SPR6EL15K	1
15° - 7"	3-3/8"	2-9/16"	2-1/16"	SPR7EL15K	1
15° - 8"	3-3/8"	2-5/8"	2-1/8"	SPR8EL15K	1

30° ELBOW

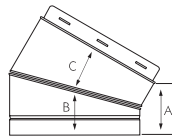

Size	Dimensions			Product Code	Pack
	A	B	C		
30° - 5"	2-3/4"	2-9/16"	2-9/16"	SPR5EL30K	1
30° - 6"	3-1/4"	3-1/16"	2-9/16"	SPR6EL30K	1
30° - 7"	3-3/4"	3-7/16"	2-15/16"	SPR7EL30K	1
30° - 8"	4-1/4"	3-7/8"	3-3/8"	SPR8EL30K	1

Stainless Steel Elbows & Tees continued

INSULATED TEE WITH PLUG

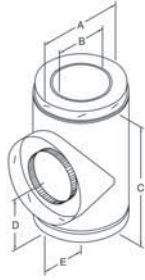

- The insulated chimney tee is used for through-the-wall installation using a wall support.
- A chimney length is attached to the tee branch using a Locking Band to pass safely through a wall.

Size	Dimensions					Product Code	Pack
	A	B	C	D	E		
5"	7"	5"	10-1/2"	5"	5"	SPR5ITP	1
6"	8"	6"	11-1/2"	5-5/8"	5-3/4"	SPR6ITP	1
7"	9"	7"	12-1/4"	6-1-4"	6-3/16"	SPR7ITP	1
8"	10"	8"	13-3-8"	6-5/8"	6-1/2"	SPR8ITP	1

INSULATED TEE PLUG

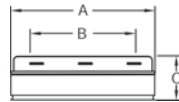

Size	Dimensions			Product Code	Pack
	A	B	C		
5"	7"	5"	2-7/8"	J51TPI	1
6"	8"	6"	2-7/8"	J61TPI	1
7"	9"	7"	2-7/8"	J71TPI	1
8"	10"	8"	2-7/8"	J81TPI	1

Supports

ADJUSTABLE WALL SUPPORT

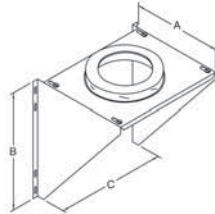

- Used to support the chimney on a through-the-wall installation.
- Will support up to 38 feet of chimney.
- Includes wall support top plate with female coupler attached, male coupler, side brackets and hardware.

Size	Dimensions			Product Code	Pack
	A	B	C		
5"	17-1/8"	10"	16"	JSC5AWS	1
6"	17-1/8"	11"	16"	JSC6AWS	1
7"	17-1/8"	12"	16"	JSC7AWS	1
8"	17-1/8"	13"	16"	JSC8AWS	1

ADJUSTABLE INTERMEDIATE WALL SUPPORT

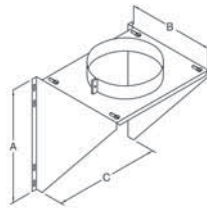

- Used as supplementary support when chimney system height exceeds maximum height allowed by Wall Support.
- Supports an additional 38 feet of chimney.
- Includes Top Plate, Support Band, Side Brackets and Hardware.

Size	Dimensions			Product Code	Pack
	A	B	C		
6"	11"	17-1/8"	16"	JSC6AIWS	1
7"	12"	17-1/8"	16"	JSC7AIWS	1
8"	13"	17-1/8"	16"	JSC8AIWS	1

Supports continued

DECORATOR CEILING SUPPORT

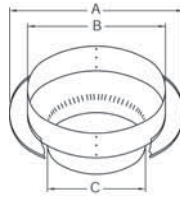

- For use in ceiling support installations.
- Supports up to 50 feet of chimney.
- Matte black finish with brass finishing ring, support gives a premium finished appearance.

Size	Dimensions			Product Code	Pack
	A	B	C		
5"	17 7/8"	11 3/8"	7 1/4"	SPR5CSB	1
6"	17 7/8"	12 3/8"	8 1/4"	SPR6CSB	1
7"	17 7/8"	13 3/8"	9 1/4"	SPR7CSB	1
8"	19 5/8"	14 3/8"	10 1/4"	SPR8CSB	1

CATHEDRAL CEILING SUPPORT BOX

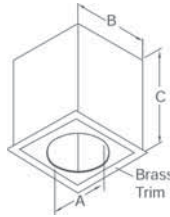

- Used in pitched ceiling support installations.
- Supports up to 38 feet of chimney.
- Matte black finish with stylish brass finishing trim.

Size	Dimensions			Product Code	Pack
	A	B	C		
5"	7-3/16"	11"	17"	SPR5CCSB	1
6"	8-3/16"	12"	17"	SPR6CCSB	1
7"	9-3/16"	13"	17"	SPR7CCSB	1
8"	10-3/16"	14"	17"	SPR8CCSB	1

Add JUSI (pg. 10) to the Cathedral Ceiling Support Box for increased performance and safety.

ROOF SUPPORT

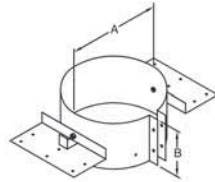

- The Roof Support may be used on a floor, ceiling or roof and adjusts to any roof pitch.
- It may be used above an offset to support the offset or as a supplementary support when the chimney height exceeds that of the primary support.
- The Roof Support will support a total height of 50 feet of chimney.

Size	Dimensions		Product Code	Pack
	A	B		
5"	7"	5"	JSC5RS	1
6"	8"	5"	JSC6RS	1
7"	9"	5"	JSC7RS	1
8"	10"	5"	JSC8RS	1

ADAPTER PLATE

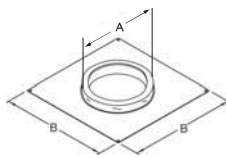
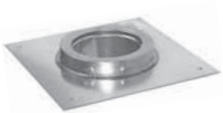

- To be used with specifically listed factory built fireplaces.

Size	Dimensions		Product Code	Pack
	A	B		
5"	7"	11-5/8"	JSC5AP	1
6"	8"	11-5/8"	JSC6AP	1
7"	9"	11-5/8"	JSC7AP	1
8"	10"	11-5/8"	JSC8AP	1

Shields

ATTIC INSULATION SHIELD

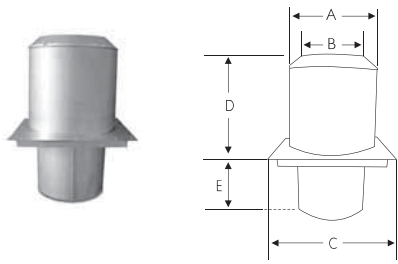

Add JUSI (pg. 10) to the Attic Insulation Shield for increased performance and safety.

- The AIS must be installed where the chimney enters the attic space in any installation.
- When fully extended the AIS provides joist shielding.
- Designed to keep insulation away from the chimney, and to maintain the mandatory 2" clearance to combustibles.
- Must be used when installing through a second floor.

Size	Dimensions					Product Code	Pack
	A	B	C	D	E		
5"	11"	7"	13"	11-13/16"	8-1/2"	JSC5AIS	1
6"	12"	8"	14"	11-13/16"	8-1/2"	JSC6AIS	1
7"	13"	9"	15"	11-13/16"	8-1/2"	JSC7AIS	1
8"	14"	10"	16"	11-13/16"	8-1/2"	JSC8AIS	1

FIRESTOP RADIATION SHIELD

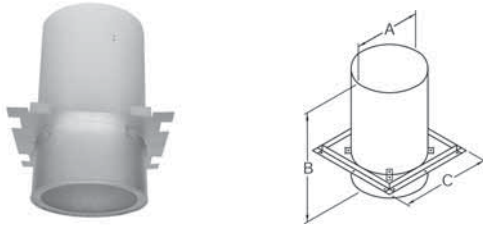

- Also known as a Firestop Joist Shield.
- Required where the chimney passes from one lower living space to another living space.
- Maintains the mandatory 2" clearance to combustibles.

Size	Dimensions			Product Code	Pack
	A	B	C		
5"	13"	9"	19"	JSC5FRS	1
6"	14"	10"	19"	JSC6FRS	1
7"	15"	11"	19"	JSC7FRS	1
8"	16"	12"	19"	JSC8FRS	1

RAFTER RADIATION SHIELD

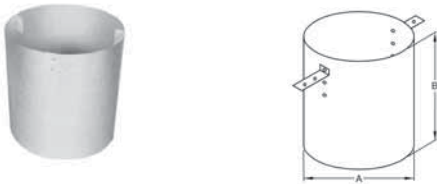

- The RRS must be installed where the chimney is enclosed immediately below the roof line.

Size	Dimensions		Product Code	Pack
	A	B		
5"	9"	12"	JSC5RRS	1
6"	10"	12"	JSC6RRS	1
7"	11"	12"	JSC7RRS	1
8"	12"	12"	JSC8RRS	1

WALL THIMBLE with BRASS TRIM

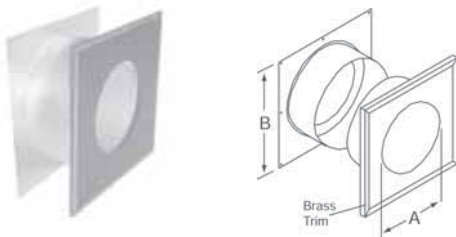

Add JUSI (pg. 10) to the Wall Thimble for increased performance and safety.

- Used in a wall support installation.
- Radiation shield is included with spacers which maintain the mandatory 2" clearance to combustibles.
- Attractive matte black finishing trim is included with stylish brass finish.
- Extends to fit 7" wall thickness.

Size	Dimensions		Product Code	Pack
	A	B		
5"	7-1/8"	16"	SPR5WTB	1
6"	8-1/8"	16"	SPR6WTB	1
7"	9-1/8"	16"	SPR7WTB	1
8"	10-1/8"	16"	SPR8WTB	1

Flashings and Storm Collars

ROOF FLASHING SELECTION CHART

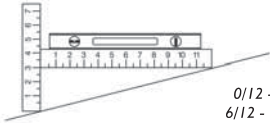

In this example, the pitch is 3/12.
 0/12 - 6/12 Roof Pitch = JSC 6 or 7 AAF
 6/12 - 12/12 Roof Pitch = JSC 6 or 7 AF2

To determine what Roof Flashing you'll require, you must work out the pitch of your roof. To determine the pitch, you'll need two rulers and a level. Measure the number of inches from the end of the level down to the roof.

ADJUSTABLE FLASHING ASSEMBLY- FLAT to 6/12

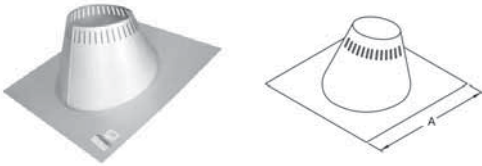

- Used where the chimney passes through a roof with a pitch of Flat to 6/12.
- Comes complete with Storm Collar.
- All seams are sealed with Silicone Sealant.
- Galvalume construction.

Size	Dimensions	Product Code	Pack
	A		
5"	24" x 24"	JSC5AAF	1
6"	24" x 24"	JSC6AAF	1
7"	30" x 24"	JSC7AAF	1
8"	27-1/2" x 27-1/2"	JSC8AAF	1
5"	24" x 24"	JSC5AAF-3	3
6"	24" x 24"	JSC6AAF-3	3
7"	24" x 24"	JSC7AAF-3	3
8"	27-1/2" x 27-1/2"	JSC8AAF-3	3

ADJUSTABLE FLASHING ASSEMBLY- 6/12 to 12/12

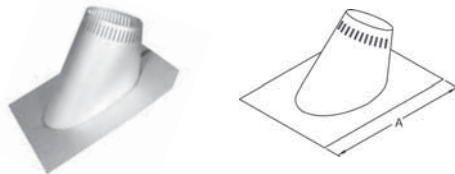

- Used where the chimney passes through a roof with a pitch of 6/12 to 12/12.
- Comes complete with Storm Collar.
- All seams are sealed with Silicone Sealant.
- Galvalume construction.

Size	Dimensions	Product Code	Pack
	A		
5"	30" x 21-1/2"	JSC5AF2	1
6"	30" x 21-1/2"	JSC6AF2	1
7"	30" x 21-1/2"	JSC7AF2	1
8"	30" x 21-1/2"	JSC8AF2	1
5"	30" x 21-1/2"	JSC5AF2-3	3
6"	30" x 21-1/2"	JSC6AF2-3	3
7"	30" x 21-1/2"	JSC7AF2-3	3
8"	30" x 21-1/2"	JSC8AF2-3	3

RUBBER BOOT FLASHING KIT



- THIS KIT INCLUDES:**
- Special Storm Collar
 - Rubber Boot
 - Spacer Kit
 - Special Boot Mounting Screws

- This kit fits 5", 6", 7" and 8" Chimneys.
- Required where the chimney passes through a corrugated roof.
- Rubber Boot Flashing fits roof pitches up to 12/12" (10/12 for 8").

Size	Product Code	Pack
ALL	200275	1

Flashings and Storm Collars continued

STORM COLLAR

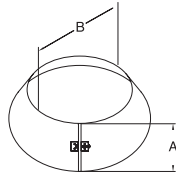

- Used in conjunction with Roof Flashing to keep precipitation out.
- Installed above the Roof Flashing.
- Provides a weather-proof seal.
- Seal inner edge with Hi-Temp Silicone Sealant.

Size	Dimensions		Product Code	Pack
	A	B		
5 1/6"	5 1/2"	7 7/8"	206810	1
7 1/8"	5 1/2"	9 1/10"	208810	1

SILICONE SEALANT FOR STORM COLLAR

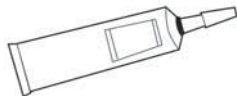

- Used to seal Storm Collar to chimney length above cone of flashing.

Size	Product Code	Pack
3 ounce tube	JRTV	1

Rain Caps

DELUXE RAIN CAP

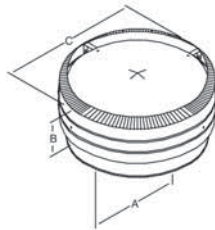

- Advanced design, premium quality stainless steel.
- Provides protection against the elements
- Twist-lock connection for secure installation.

Size	Dimensions			Product Code	Pack
	A	B	C		
5"	7"	7-1/8"	11-1/4"	SPR5DRC	1
6"	8"	7-1/4"	11-1/4"	SPR6DRC	1
7"	9"	7-1/2"	13-1/4"	SPR7DRC	1
8"	10"	7-5/8"	14-1/4"	SPR8DRC	1

SPARK ARRESTOR

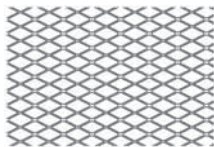

- Stainless steel mesh wire fits inside Rain Cap (SPR*DRC)

Size	Dimensions	Product Code	Pack
5"	4-1/2" x 26"	JSC5SPAR	10
6"	4-1/2" x 26"	JSC6SPAR	10
7"	4-1/2" x 29"	JSC7SPAR	10
8"	4-1/2" x 32"	JSC8SPAR	10

Parts and Accessories

WALL BAND

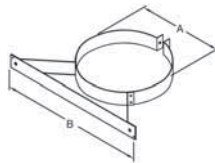

- Stainless steel construction.
- Provides lateral support for the chimney when installed adjacent to a wall.
- Maintains the mandatory 2" clearance to combustibles.
- Installed on first length above the Tee, then every 8 feet thereafter.

Size	Dimensions		Product Code	Pack
	A	B		
5"	7"	17"	JSC5WB	1
6"	8"	17"	JSC6WB	1
7"	9"	17"	JSC7WB	1
8"	10"	17"	JSC8WB	1

Parts and Accessories continued

BLACK STOVE PIPE ADAPTER



- For a quick and easy transition from black stove pipe to factory-built chimney.
- Twist-lock for easy connection.

Size	Dimensions			Product Code	Pack
	A	B	C		
5"	7"	5"	7"	JSC5ASE	1
6"	8"	6"	7"	JSC6ASE	1
7"	9"	7"	7"	JSC7ASE	1
8"	10"	8"	7"	JSC8ASE	1

FINISHING PLATE

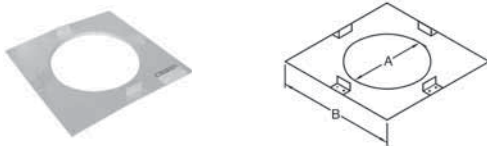

- Used where the chimney passes through a soffit to provide a finished appearance.
- Maintains the mandatory 2" clearance to combustibles.

Size	Dimensions		Product Code	Pack
	A	B		
5"	7-1/8"	13"	JSC5FP	1
6"	8-1/8"	14"	JSC6FP	1
7"	9-1/8"	15"	JSC7FP	1
8"	10-1/8"	16"	JSC8FP	1

MATTE BLACK TRIM COLLAR WITH BRASS TRIM

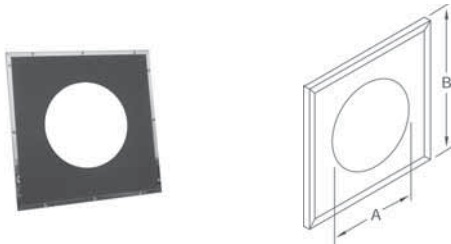

- Used on wall support installations when passing through a non-combustible wall.
- Matte black finish with brass trim for an enhanced hand-crafted appearance.

Size	Dimensions		Product Code	Pack
	A	B		
5"	7-1/8"	16-1/8"	SPR5TCB	10
6"	8-1/8"	16-1/8"	SPR6TCB	10
7"	9-1/8"	16-1/8"	SPR7TCB	10
8"	10-1/8"	16-1/8"	SPR8TCB	10

ADJUSTABLE UNIVERSAL ROOF GUY KIT

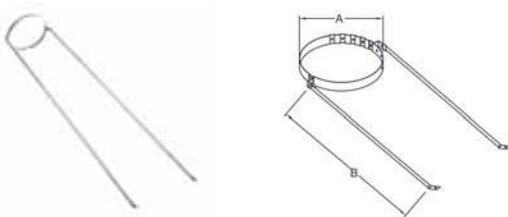

- Used when more than 5 feet of chimney extends from the roof.
- The kit includes two 5 foot rods and an adjustable band.
- Each rod extends to approximately 10 feet.
- The adjustable band will fit 5" to 8" size chimney.

Size	Dimensions		Product Code	Pack
	A	B		
	7"-10"	60" 120"	JURGK-1	1

JUSI-UNIVERSAL SHIELDING INSULATION

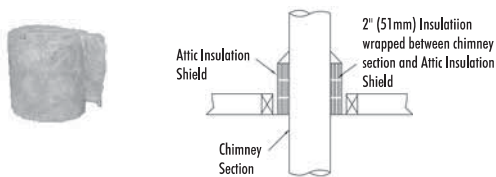

- Insulation for use with:
 - Attic Insulation Shield (JSC*AIS)
 - Wall Thimble (JSC*WT)
 - Cathedral Ceiling Support (JSC*CCS)
- Stops cold air infiltration into the dwelling.
- Provides additional protection against heat from the chimney.

Size	Dimensions	Product Code	Pack
Universal		JUSI	1

Typical Installations



DECORATOR CEILING SUPPORT INSTALLATIONS

One Story

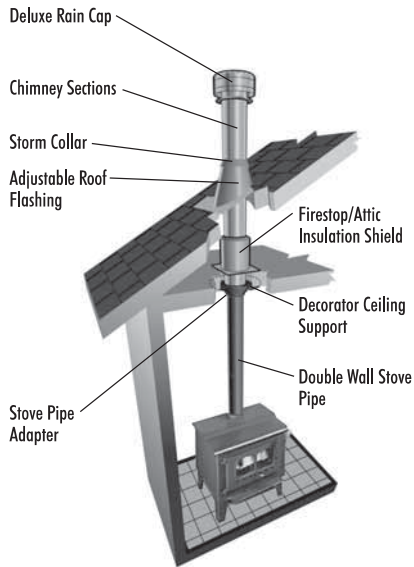

Two Story

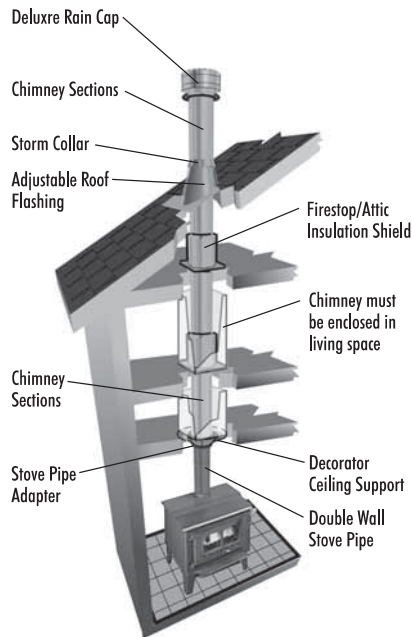

Elbow Installation

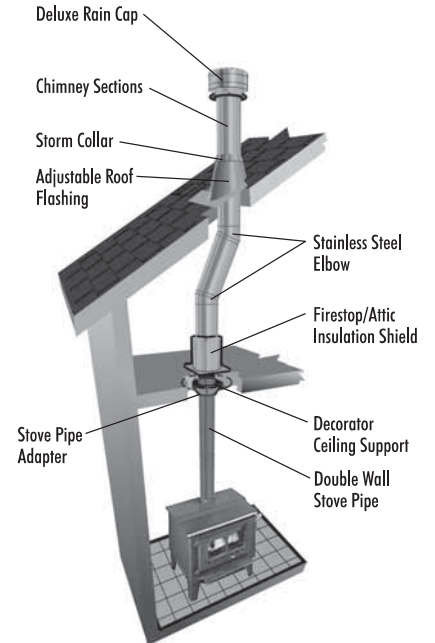

WALL SUPPORT INSTALLATIONS

One Story

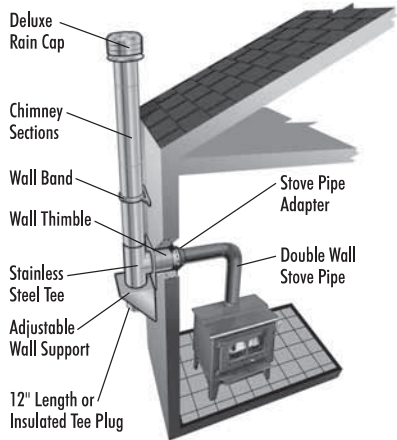

Through a Soffit

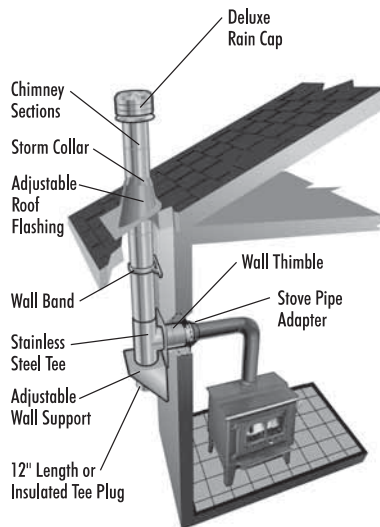

CATHEDRAL SUPPORT INSTALLATION

With Cathedral Ceiling Support Box

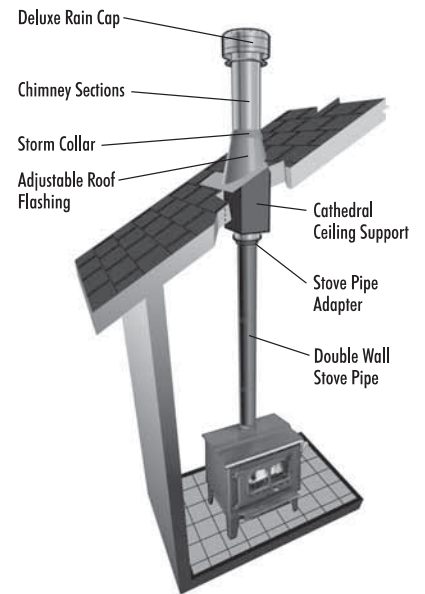



Premium Grade Stainless Steel Factory-Built Chimney
**For the Chimney Professional
 Who Demands the Best...**

Introducing a better designed chimney that tops all other factory-built chimney installations.
 SuperPro offers the latest technology in factory-built chimney design - providing superior performance, durability and safety. SuperPro is able to perform at a level that will match today's technically efficient appliances, which are engineered to produce low emissions and high heat.

SUPERPRO

**SALES OFFICES &
 CUSTOMER SERVICE**

UNITED STATES

1301 W. President George Bush Hwy,
 Suite 330
 Richardson, Texas 75080-1139
 (800) 992-8368 (VENT)
 Toll Free Fax: (877) 393-4145
 www.selkirkcorp.com

CANADA

375 Green Road
 Stoney Creek, Ontario
 Canada L8E 4A5
 (905) 662-6600
 Fax: (905) 662-5352
 www.selkirkcanada.com

TECHNICAL SUPPORT

REGISTER, GRILLE & DIFFUSER

(800) 992-8368
 Fax: (877) 393-4145
 Email: Airmatesupport@selkirkinc.com

CHIMNEY & VENTING

US - (800) 848-2149 ext. 2212
 Fax: (740) 385-2483
 Email: Metalbestosupport@selkirkinc.com
 CANADA - (888) SELKIRK (735-5475)
 Fax: (866) 835-9624
 Email: info@selkirkcanada.com

R&D UNITED STATES

VENTING R&D

St. Rt. 93 N. & Sutton Rd.
 Logan, Ohio 43138
 (740) 385-5666
 Fax: (740) 385-2483

**MANUFACTURING PLANTS
 & FACILITIES**

UNITED STATES

1820 E. Fargo Ave.
 Nampa, Idaho 83687-6824
 (208) 467-7411
 Fax: (208) 467-7412

130 Industrial Blvd.
 Turners Falls, MA 01376
 (800) 772-0739
 Fax: 413-863-4803

7571 West Highway 153
 P.O. Box 427
 Winters, Texas 79567
 (325) 754-4571
 Fax: (325) 754-4764

CANADA

R.R. #1 Woods Road
 Nobel, ON POG 1G0
 (705) 342-5236
 Fax (705) 342-5238

MEXICO

Justo Sierra Y 2 da Avenida
 Ojinaga, Chihuahua, Mexico
 011 52 (626) 453-2884/85
 Fax: 011 52 (626) 453-2886

R&D CANADA

VENTING R&D

375 Green Road
 Stoney Creek, Ontario, Canada L8E 4A5
 (905) 662-6600
 Fax: (905) 662-5352

CONDITIONS OF SALE

WARRANTY

All Selkirk Corporation venting products are now backed with a Lifetime Limited Warranty. Please refer to the warranty included with the product for specific details or contact customer service for a copy.

PRICES & DISCOUNTS

See our price list and discount sheet for current pricing information. Orders will be invoiced at prices in effect at time order is placed. All prices subject to change without notice. All Selkirk products may be combined to achieve required discount levels.

CREDIT

Shipments will be made on open account to those firms with established credit ratings with us.

RESPONSIBILITY

Selkirk cannot assume responsibility for loss or damages to products in transit or for delays of carriers delivering our products. In case of loss, visible or concealed damage, you as a consignee must report such loss to carrier at once and file a claim.

FREIGHT

All shipments are F.O.B. our facilities.

RETURNED GOODS

No merchandise may be returned for credit without prior written permission, shipping instructions and return authorization number. All items authorized for return must be in new and resalable condition in unopened cartons and transportation charges must be prepaid. A 25% restocking charge will be made on all returns to cover the costs of handling and inspection. Up to a 15% refurbishment charge will be applied as needed.

BROKEN CARTONS

Any order requiring quantities of product less than a complete carton will be charged an additional fee. Please contact your local representative for pricing.

TRANSPORTATION

Method of transportation and shipping point will be decided by Selkirk Corporation. If our customer requests special routing, the order will be shipped prepaid and charged.

BTO/SPECIAL ORDER

Build to Order or Special Order items may not be cancelled or returned.

Customer Service

US: (800) 992-8368

CANADA: (888) 735-5475

Fax Orders

US: Toll Free (877) 393-4115

CANADA: (866) 835 9625

SELKIRK Corporation is a leading manufacturer of venting products for residential, commercial and industrial applications. Current operations include locations in the United States, Canada and Mexico. SELKIRK has been supplying the finest venting products for over 80 years.

US - (800) 992-8368 (VENT)
 www.selkirkcorp.com

CANADA - (888) 735-5475 (SELKIRK)
 www.selkirkcanada.com

